

Artwork Information



When producing artwork for large format posters, please adhere to the following guidelines. If you require further information, please contact us on 01223 833522.

Format

Only artwork generated using Apple Macintosh hardware/software must be submitted (we cannot accept images embedded into Microsoft Word or Microsoft PowerPoint files). Produce artwork to scale in a logical proportion to the final size, e.g. 1:10 Allow bleed.

Software

- QuarkXpress:** Ensure all images and fonts are supplied. All colours used in file must be CMYK or spot colours. Delete all unused colours.
- Adobe Photoshop:** Supply CMYK, EPS, TIFF or JPEG. Do not use desktop colour separations (DCS).
- Adobe Illustrator/
Adobe InDesign/
Freehand MX:** We prefer EPS. All fonts to be converted to outlines or fonts supplied. Delete all empty text boxes and unused colours. Please supply all embedded scans.
- Extensis Suitcase:** Do not use TrueType fonts. To avoid font conflicts, convert all fonts to outlines/paths. If this is not possible, supply the relevant font suitcase. When compressing fonts, use Stuffit, do not Zip (this often corrupts them).
- Adobe Acrobat:** High resolution PDFs must have all fonts embedded with scans with no JPEG compression. Distillers "Job Options" setting for Rutters can be sent via email upon request.

File Size Guide

File sizes for all artwork formats:

4 Sheet: 35 - 40 Mb	Interior: 20 - 25 Mb
6 Sheet: 70 - 80 Mb	Bus Rear: 30 - 35 Mb
16 Sheet: 80 - 100 Mb	Streetliner: 60 - 70 Mb
48 Sheet: 100 - 120 Mb	Superside: 70 - 80 Mb
96 Sheet: 160 - 200 Mb	T-Side: 90 - 100 Mb

How to Supply Files

- Mail:** Artwork files can be sent on CD/DVD as well as the following methods:
- Email:** File sizes up to 10 Mb maximum can be emailed to: art@ruttersuk.com
- Bigger Files:** There are now online facilities that enable the transfer of large files. We are aware that for a 'rush job' you may need to send a file this way and suggest you use services such as those provided by memeo.com, and yousendit.com.

Telephone: 01223 833522

Email: info@ruttersuk.com

When supplying files, please ensure folders are correctly named and include a contact name/telephone number. Artwork produced outside of these specifications may result in additional charges and a delay in production.

Artwork Information

Large Poster Formats



large format posters

6 Sheet or Superlite



Contractor	Size	Safe Area
More O Ferrall / Adshel	1800mm x 1200mm	1760mm x 1160mm
Decaux	1750mm x 1185mm	1710mm x 1160mm
Primesite	1800mm x 1200mm	1720mm x 1160mm

4 Sheet Poster



60" x 40", 1524mm x 1016mm.
This size is usually referred to as a 4 sheet poster and is regularly used for outdoor advertising.
Multiples of this are used to create larger hoarding sizes, 16 sheet, 32 sheet, 48 sheet and 96 sheet posters.
The Viacom display area is 1474mm x 966mm.

12 Sheet Poster

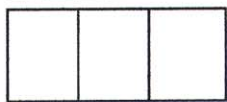

60" x 120", 1524mm x 3048mm.
A 12 sheet poster comprising three 60 x 40 sections joined.
The Viacom display area is 1474mm x 2998mm.

16 Sheet Poster

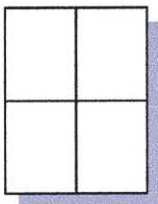

120" x 80", 3048mm x 2032mm.
A 16 sheet poster comprising four 60 x 40 sections joined.
The Viacom display area is 2983mm x 1967mm.

32 Sheet Poster

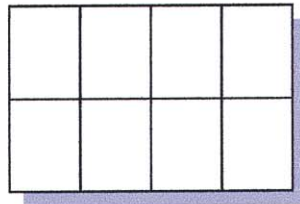

120" x 160", 3048mm x 4064mm.
A 32 sheet poster comprising eight 60 x 40 sections joined.

48 Sheet Poster

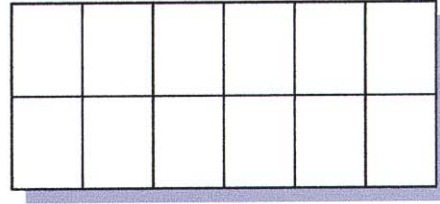

120" x 240", 3048mm x 6096mm.
A 48 sheet poster comprising twelve 60 x 40 sections joined. Recommended safe area to 200mm (8") from the right hand side.
The Viacom display area is 2983mm x 6031mm.

96 Sheet Poster

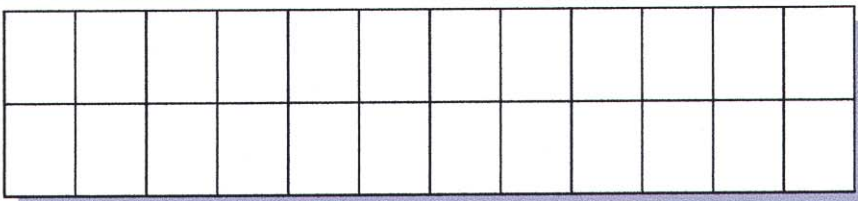

120" x 480", 3048mm x 12192mm. A 96 sheet poster comprising twenty four 60 x 40 sections joined.
Recommended safe area to 400mm (16") from the right hand side. The Viacom display area is 2983mm x 12127mm.

Quad

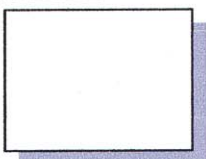

30" x 40", 762mm x 1016mm.

D. Royal



40" x 25", 1016mm x 635mm.

D. Crown

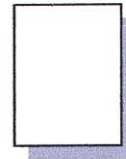

30" x 20", 762mm x 508mm.

Artwork Information



Transport Advertising Poster Formats

large format posters

Supersides including Stagecoach Supertram and Croydon Tramlink

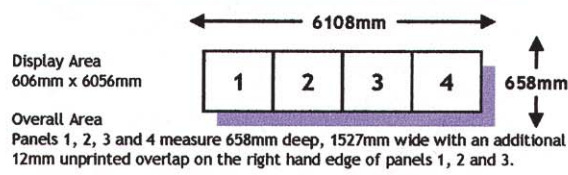

T Sides - Forward Stem

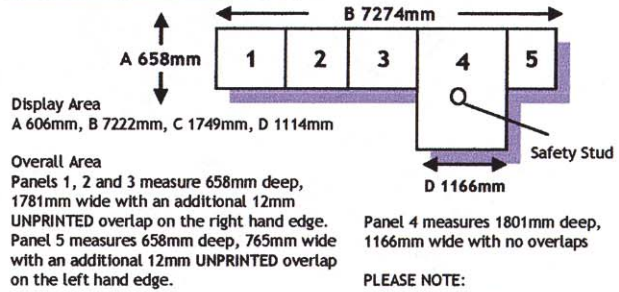

T Sides - Centre Stem

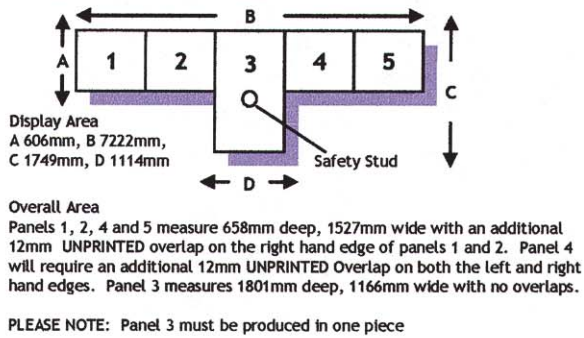

T Sides - Off-Centre Stem

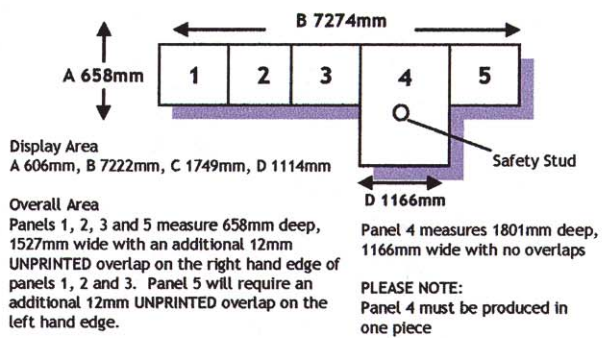

Streetliners - 10 Foot

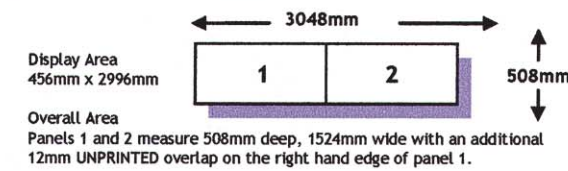

Streetliners - 13 Foot

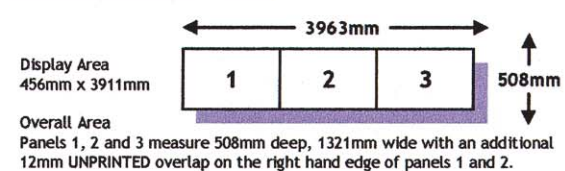

Standard and Routmaster Rears

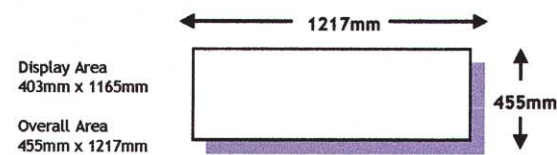

Super Rears

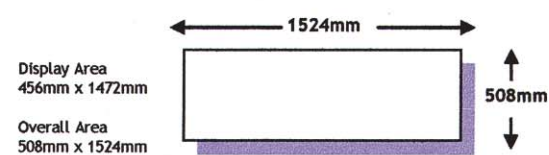

Headliners

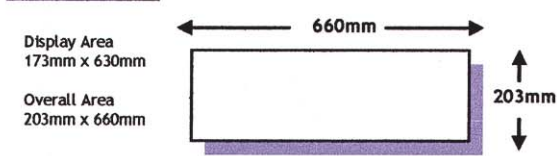

London Super Headliners

